

# GENERAL CATALOG



**- VARIOUS POWER**

---



**- FROM 300W TO 30KW  
POWER**

---

**- STANDARD CONFIGURATION  
OF 2 CAVITIES**

---

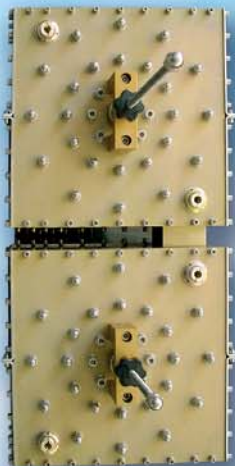

**- SPECIAL CONFIGURATION  
3 AND 4 CAVITIES**

---

**- LOW LOSS,  
HIGH ISOLATION**

---

## Model FFC03

- **Band-Pass Filter**
- **FM Band 87.5÷108 MHz**
- **Band II**

**THESE ARE TWO STANDARD RESONANT CAVITY FILTERS, AND IN THE SPECIAL VERSION WITH 3 AND 4.**

**ALL THE MODELS ARE USED TO MAKE UP MIXERS WITH SEVERAL CHANNELS.**

The band pass filters was designed as an extension of our band pass combiner technology. Using our industry-leading square, octagonal, cavity filter design, the filter provides a one-time-buy filtering solution for the broadcaster located at multiple-user site. The filter isolates the transmission system to eliminate spurious emissions.

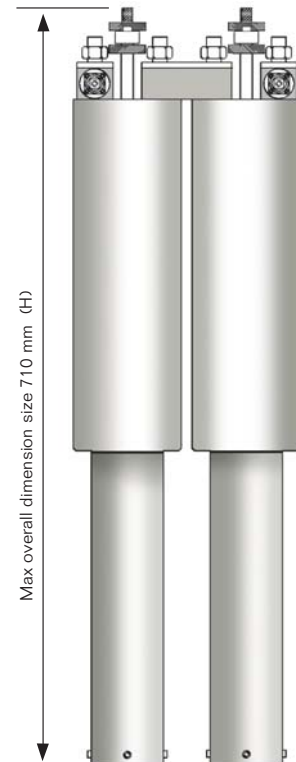
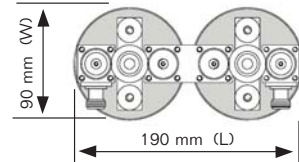
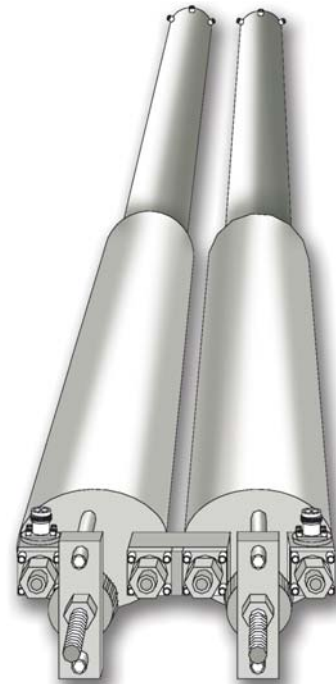

### TYPICAL SPECIFICATIONS

Model	FFC03
Impedance	50 Ohm
Frequency Range	87.5÷108 MHz
VSWR ±150 KHz	1.1:1 Max
Insertion Loss	at $f_0$ 0.6 dB Max
Return Loss ±150 KHz	≤ -26 dB
Rejection	per customer's requirements (Typical ±1MHz it's even to -8 dB)
Connectors	N Input-Output
Max Power	300 W
Working Temperature	-20°C ÷ +50°C
Colour	Enamel gray ral 7001
Materials	Aluminium, silver brass, copper, PTFE, stainless steel, silver plated (min 12μ thickness)

### Features:

- Distortion – Free Transmission
- Standard configuration of 2 cavities
- Special configuration 3 and 4 cavities
- Low loss, high isolation
- Natural convection

### No Rack Version

Dimensions	710 (Max size) x 190 x 90 mm (28-Max Size-x7.5x3.5 inch) (HxLxW)
Net Weight	≅ 6 Kg

### Rack Version (optional)

Panel Size	2 HE (1 HE = 44.45 mm)
Net Weight	≅ 6 Kg

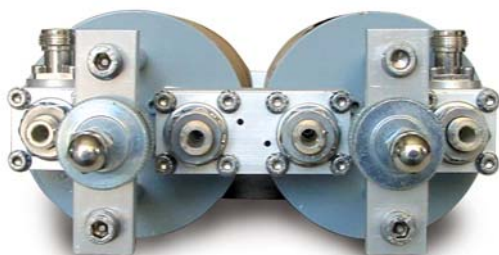

"These specifications are subject to change without notice"

- Triple Cavity Version
- Band-Pass Filter
- FM Band 87.5÷108 MHz
- Band II

THESE ARE TWO STANDARD RESONANT CAVITY FILTERS, AND IN THE SPECIAL VERSION WITH 3 AND 4.

ALL THE MODELS ARE USED TO MAKE UP MIXERS WITH SEVERAL CHANNELS.

The band pass filters was designed as an extension of our band pass combiner technology. Using our industry-leading square, octagonal, cavity filter design, the filter provides a one-time-buy filtering solution for the broadcaster located at multiple-user site. The filter isolates the transmission system to eliminate spurious emissions.



### TYPICAL SPECIFICATIONS

Model	FFTC03 Triple cavity version
Impedance	50 Ohm
Frequency Range	87.5÷108 MHz
VSWR ±150 KHz	1.1:1 Max
Insertion Loss	at $f_0$ 0.8 dB Max
Return Loss ±150 KHz	≤ -26 dB
Rejection	per customer's requirements (Typical ±1MHz it's even to -14 dB)
Connectors	N Input-Output
Max Power	300 W
Working Temperature	-20°C ÷ +50°C
Colour	Enamel gray 7001
Materials	Aluminium, silver brass, copper, PTFE, stainless steel, silver plated (min 12μ thickness)

### Features:

- Distortion – Free Transmission
- Standard configuration of 2 cavities
- Special configuration 3 and 4 cavities
- Low loss, high isolation
- Natural convection

### No Rack Version

Dimensions	710 (Max size) x 280 x 90 mm (28-Max Size-x11x3.5 inch) (HxLxW)
Net Weight	≅ 9 Kg (triple cavity)

### Rack Version (optional)

Panel Size	2 HE (1 HE = 44.45 mm)
Net Weight	≅ 9 Kg (triple cavity)

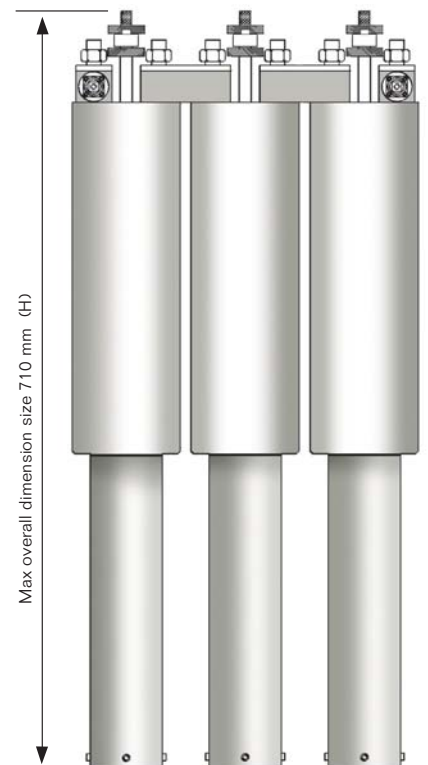
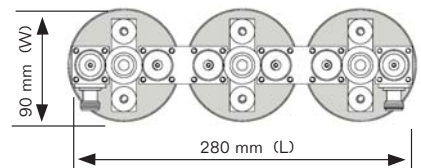

Typical shape of a curves for S11 and S21 parameters

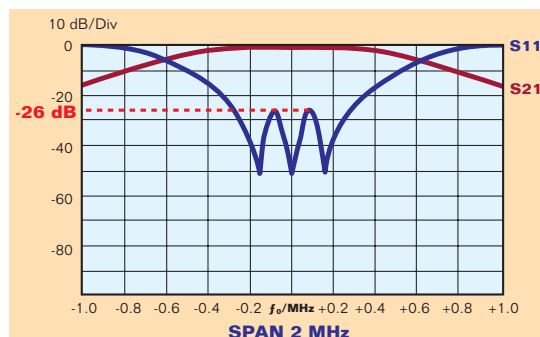

"These specifications are subject to change without notice"

## Model FFC05

- Band-Pass Filter
- FM Band 87.5÷108 MHz
- Band II

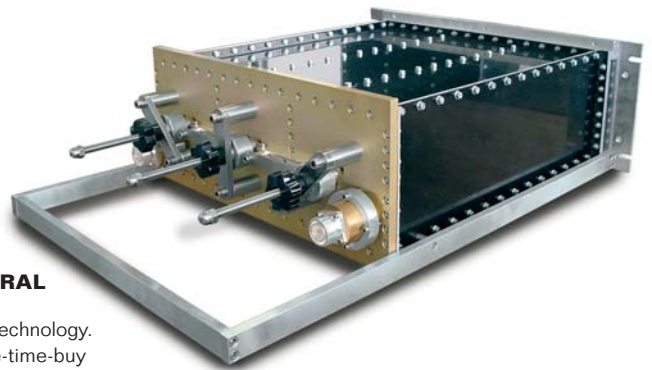

**THESE ARE THREE STANDARD RESONANT CAVITY FILTERS. ALL THE MODELS ARE USED TO MAKE UP MIXERS WITH SEVERAL CHANNELS.**

The band pass filters was designed as an extension of our band pass combiner technology. Using our industry-leading square, cavity filter design, the filter provides a one-time-buy filtering solution for the broadcaster located at multiple-user site. The filter isolates the transmission system to eliminate spurious emissions.

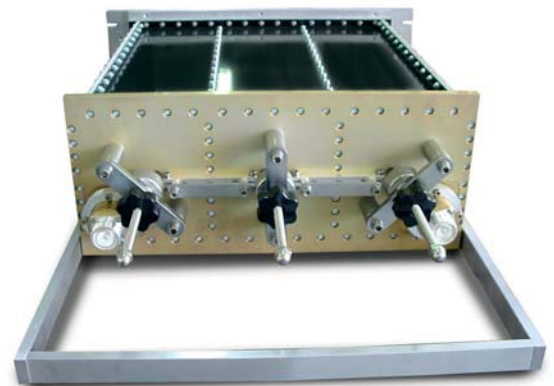

### TYPICAL SPECIFICATIONS

Model	FFC05
Impedance	50 Ohm
Frequency Range	87.5÷108 MHz
VSWR $\pm 150$ KHz	1.1:1 Max
Insertion Loss	at $f_0$ 0.65 dB Max
Return Loss $\pm 150$ KHz	$\leq -26$ dB
Rejection	per customer's requirements (Typical $\pm 1$ MHz it's even to $-14$ dB)
Connectors	7/16" Input-Output (Option 7/8" EIA)
Max Power	600 W
Working Temperature	$-20^\circ\text{C} \div +50^\circ\text{C}$
Colour	Enamel gray ral 7001
Materials	Aluminium, silver brass, copper, PTFE, stainless steel, silver plated (min $12\mu$ thickness)

### Features:

- Distortion – Free Transmission
- Standard configuration of 3 cavities
- Low loss, high isolation
- Natural convection

### No Rack Version

Dimensions	680 (Max size) x 400 x 175 mm (26.8-Max Size-X15.7x6.9 inch) (HxLxW)
Net Weight	$\cong 25$ Kg

### Rack Version (optional)

Panel Size	4 HE (1 HE = 44.45 mm)
Net Weight	$\cong 25$ Kg

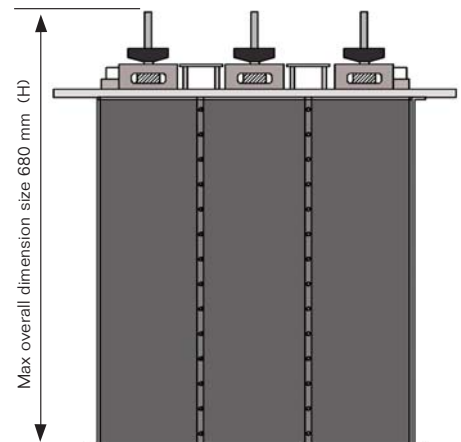
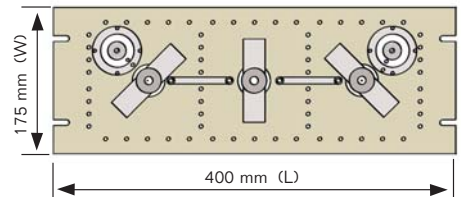

Typical shape of a curves for S11 and S21 parameters

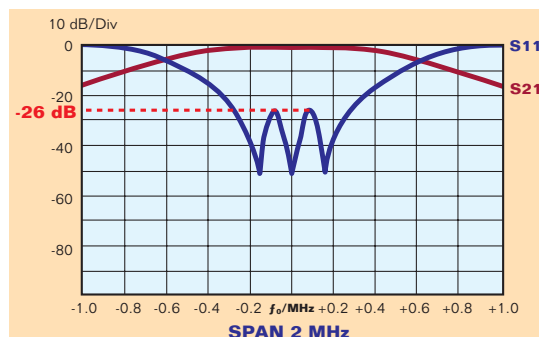

"These specifications are subject to change without notice"



## Model FFC08 - FFC2 - FFC2/78

- **Band-Pass Filter**
- **FM Band 87.5÷108 MHz**
- **Band II**

**THESE ARE TWO STANDARD RESONANT CAVITY FILTERS, AND IN THE SPECIAL VERSION WITH 3 AND 4. ALL THE MODELS ARE USED TO MAKE UP MIXERS WITH SEVERAL CHANNELS.**

The band pass filters was designed as an extension of our band pass combiner technology. Using our industry-leading squarecavity filter design, the filter provides a one-time-buy filtering solution for the broadcaster located at multiple-user site. The filter isolates the transmission system to eliminate spurious emissions.



### TYPICAL SPECIFICATIONS

Model	FFC08 - FFC2 - FFC2/78
Impedance	50 Ohm
Frequency Range	87.5÷108 MHz
VSWR ±150 KHz	1.1:1 Max
Insertion Loss	at $f_0$ 0.28 dB Max
Return Loss ±150 KHz	≤ -26 dB
Rejection	per customer's requirements (Typical ±1MHz it's even to -14 dB)
Connectors	FFC08 - N Input-Output FFC2 - 7/16" Input-Output FFC2/78 - 7/8" Input-Output
Max Power	2 KW (FFC2 - FFC2/78) 800 W (FFC08)
Working Temperature	-20°C + +50°C
Colour	Enamel gray ral 7001
Materials	Aluminium, silver brass, copper, PTFE, stainless steel, silver plated (min 12μ thickness)

### Features:

- Distortion – Free Transmission
- Standard configuration of 2 cavities
- Special configuration 3 and 4 cavities
- Low loss, high isolation
- Natural convection

### No Rack Version

Dimensions	1300 (Max size) x 400 x 235mm (51.2-Max Size×15.7×9.2 inch) (HxLxW)
Net Weight	≅ 20 Kg (double cavity)

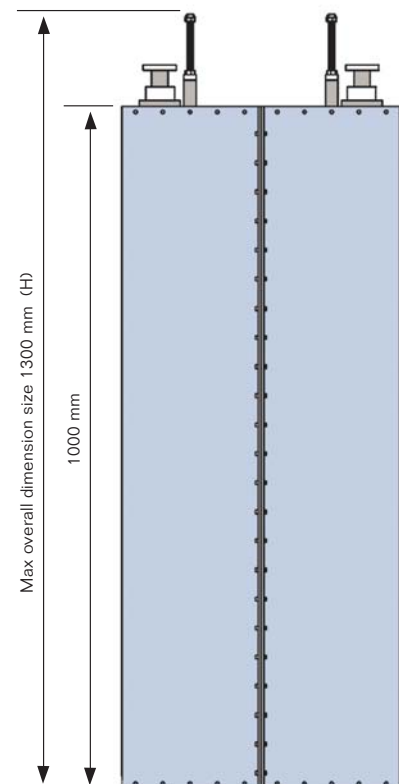
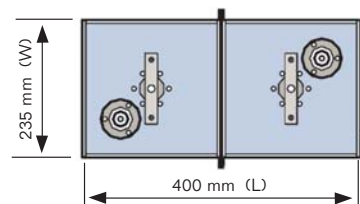

Typical shape of a curves for S11 and S21 parameters

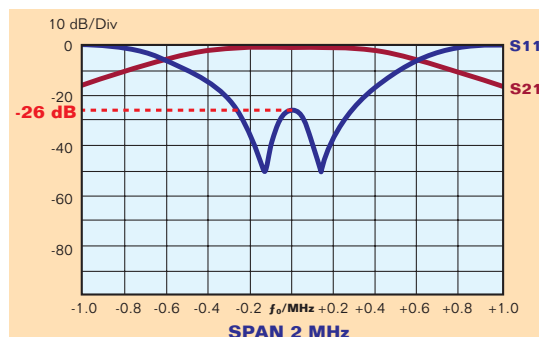

"These specifications are subject to change without notice"

## Model FFC3

- **Band-Pass Filter**
- **FM Band 87.5÷108 MHz**
- **Band II**

**THESE ARE TWO STANDARD RESONANT CAVITY FILTERS, AND IN THE SPECIAL VERSION WITH 3 AND 4.**

**ALL THE MODELS ARE USED TO MAKE UP MIXERS WITH SEVERAL CHANNELS.**

The band pass filters was designed as an extension of our band pass combiner technology. Using our industry-leading squarecavity filter design, the filter provides a one-time-buy filtering solution for the broadcaster located at multiple-user site.

The filter isolates the transmission system to eliminate spurious emissions.

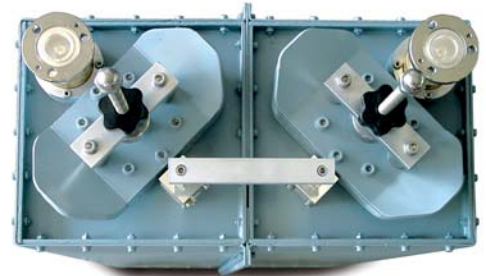

### TYPICAL SPECIFICATIONS

Model	FFC3
Impedance	50 Ohm
Frequency Range	87.5÷108 MHz
VSWR ±150 KHz	1.1:1 Max
Insertion Loss	at $f_0$ 0.25 dB Max
Return Loss ±150 KHz	≤ -26 dB
Rejection	per customer's requirements (Typical ±1MHz it's even to -14 dB)
Connectors	7/8" EIA Input-Output
Max Power	3 KW
Working Temperature	-20°C ÷ +50°C
Colour	Enamel gray ral 7001
Materials	Aluminium, silver brass, copper, PTFE, stainless steel, silver plated (min 12μ thickness)

### Features:

- Distortion – Free Transmission
- Standard configuration of 2 cavities
- Special configuration 3 and 4 cavities
- Low loss, high isolation
- Natural convection

### No Rack Version

Dimensions	1300 (Max size) x 400 x 235 mm (51.2-Max Size-x15.7x9.2 inch) (HxLxW)
Net Weight	≈ 25 Kg (double cavity)

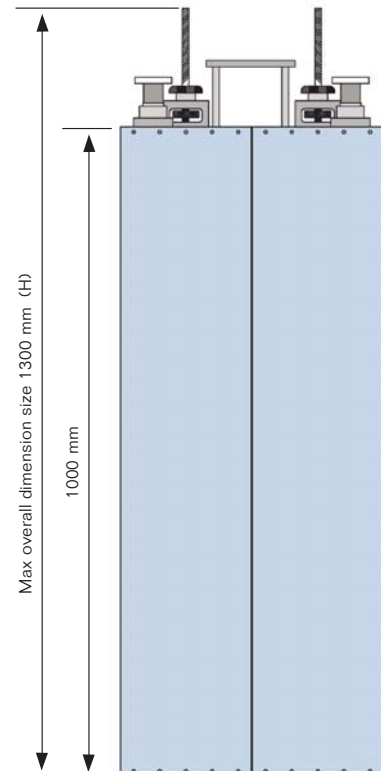
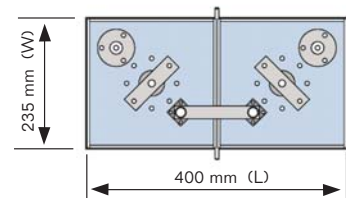

Typical shape of a curves for S11 and S21 parameters

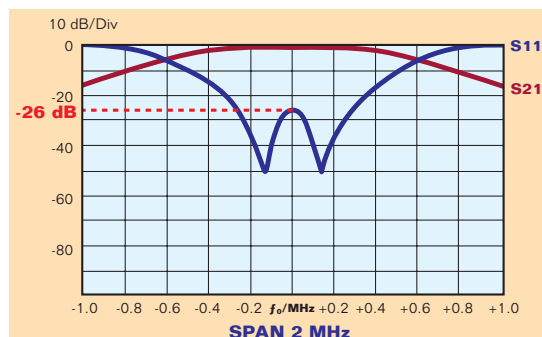

"These specifications are subject to change without notice"

- Triple Cavity Version
- Band-Pass Filter
- FM Band 87.5÷108 MHz
- Band II

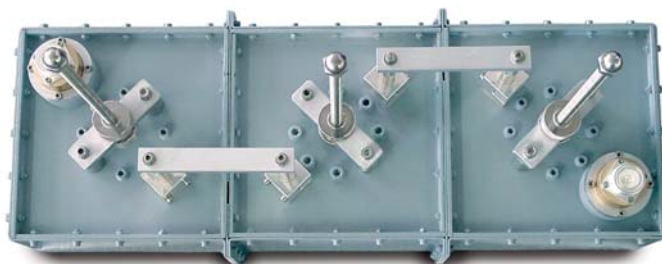

**THESE ARE TWO STANDARD RESONANT CAVITY FILTERS, AND IN THE SPECIAL VERSION WITH 3 AND 4. ALL THE MODELS ARE USED TO MAKE UP MIXERS WITH SEVERAL CHANNELS.**

The band pass filters was designed as an extension of our band pass combiner technology. Using our industry-leading squarecavity filter design, the filter provides a one-time-buy filtering solution for the broadcaster located at multiple-user site.

The filter isolates the transmission system to eliminate spurious emissions.

### TYPICAL SPECIFICATIONS

Model	FFTC3 triple cavity
Impedance	50 Ohm
Frequency Range	87.5÷108 MHz
VSWR ±150 KHz	1.1:1 Max
Insertion Loss	at $f_0$ 0.35 dB Max
Return Loss ±150 KHz	≤ -26 dB
Rejection	per customer's requirements (Typical ±1MHz it's even to -23 dB)
Connectors	7/8" EIA Input-Output
Max Power	3 KW
Working Temperature	-20°C ÷ +50°C
Colour	Enamel gray ral 7001
Materials	Aluminium, silver brass, copper, PTFE, stainless steel, silver plated (min 12μ thickness)

### Features:

- Distortion – Free Transmission
- Standard configuration of 2 cavities
- Special configuration 3 and 4 cavities
- Low loss, high isolation
- Natural convection

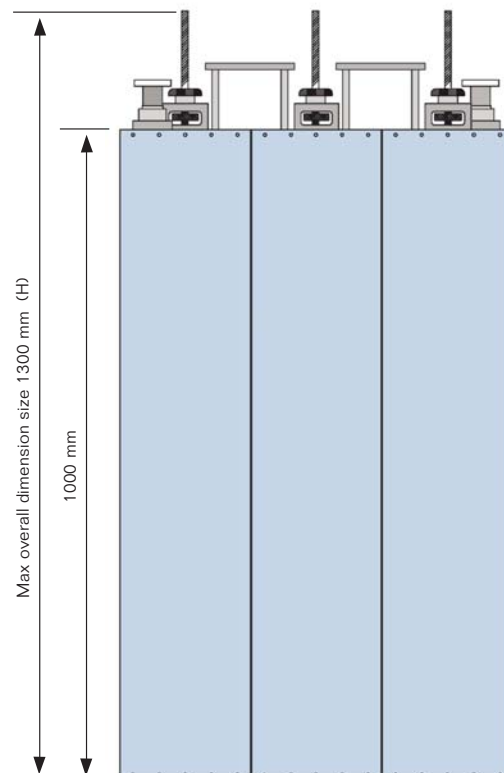
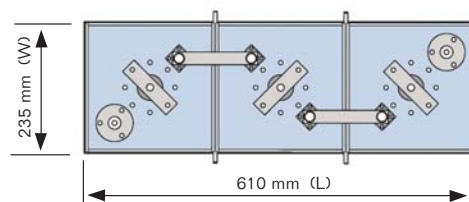

"These specifications are subject to change without notice"

### No Rack Version

Dimensions	1300 (Max size) x 610 x 235 mm (51.2-Max Size-x24x9.2 inch) (HxLxW)
Net Weight	≈ 37 Kg (double cavity)

## Model FFC5

- Band-Pass Filter
- FM Band 87.5÷108 MHz
- Band II

**THESE ARE TWO STANDARD RESONANT CAVITY FILTERS, AND IN THE SPECIAL VERSION WITH 3 AND 4.**  
**ALL THE MODELS ARE USED TO MAKE UP MIXERS WITH SEVERAL CHANNELS.**

The band pass filters was designed as an extension of our band pass combiner technology. Using our industry-leading squarecavity filter design, the filter provides a one-time-buy filtering solution for the broadcaster located at multiple-user site. The filter isolates the transmission system to eliminate spurious emissions.

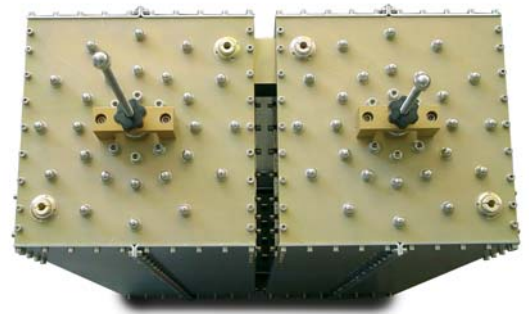

### TYPICAL SPECIFICATIONS

Model	FFC5
Impedance	50 Ohm
Frequency Range	87.5÷108 MHz
VSWR ±150 KHz	1.1:1 Max
Insertion Loss	≤ 0.15 dB
Return Loss ±150 KHz	≤ -26 dB
Rejection	per customer's requirements (Typical ±1MHz it's even to -14 dB)
Connectors	1+5/8" Input-Output (Option 7/8" - 3+1/8")
Max Power	5 KW
Working Temperature	-20°C ÷ +50°C
Colour	Enamel gray ral 7001
Materials	Aluminium, silver brass, copper, PTFE, stainless steel, silver plated (min 12µ thickness)

### Features:

- Modular design
- Distortion – Free Transmission
- Standard configuration of 2 cavities
- Special configuration 3 and 4 cavities
- Low loss, high isolation
- Natural convection

### No Rack Version

Dimensions	1400 (Max size) x 700 x 335 mm (55.1-Max Size-x27.6x13.2 inch) (HxLxW)
Net Weight	≅ 45 Kg (double cavity)

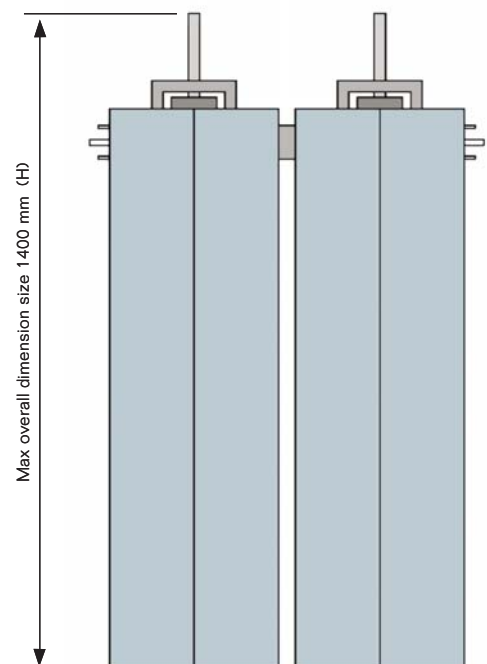
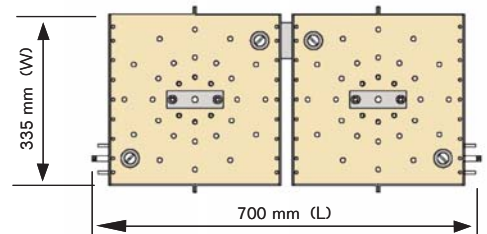

Typical shape of a curves for S11 and S21 parameters

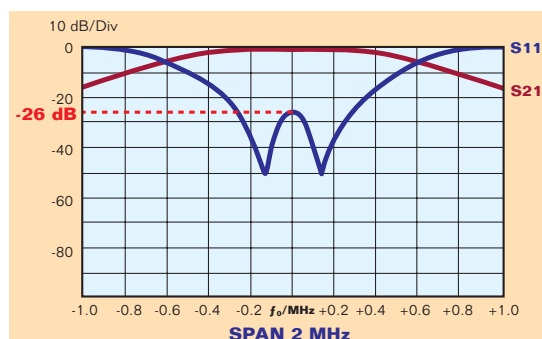

"These specifications are subject to change without notice"



- Compact Version
- Band-Pass Filter
- FM Band 87.5÷108 MHz
- Band II

**THESE ARE TWO STANDARD RESONANT CAVITY FILTERS, AND IN THE SPECIAL VERSION WITH 3 AND 4.**  
**ALL THE MODELS ARE USED TO MAKE UP MIXERS WITH SEVERAL CHANNELS.**

The band pass filters was designed as an extension of our band pass combiner technology. Using our industry-leading squarecavity filter design, the filter provides a one-time-buy filtering solution for the broadcaster located at multiple-user site.

The filter isolates the transmission system to eliminate spurious emissions.



### TYPICAL SPECIFICATIONS

Model	FFC10/C compact version
Impedance	50 Ohm
Frequency Range	87.5÷108 MHz
VSWR ±150 KHz	1.1:1 Max
Insertion Loss	≤ 0.15 dB
Return Loss ±150 KHz	≤ -26 dB
Rejection	per customer's requirements (Typical ±1MHz it's even to -14 dB)
Connectors	1+5/8" Input-Output (Option 3+1/8")
Max Power	10 KW
Working Temperature	-20°C ÷ +50°C
Colour	Enamel gray ral 7001
Materials	Aluminium, silver brass, copper, PTFE, stainless steel, silver plated (min 12μ thickness)

### Features:

- Modular design
- Distortion – Free Transmission
- Standard configuration of 2 cavities
- Special configuration 3 and 4 cavities
- Low loss, high isolation
- Forced air cooling

### No Rack Version

Dimensions	1400 (Max size) x 700 x 320 mm (55.1-Max Size-x27.6x12.6 inch) (HxLxW)
Net Weight	≅ 46 Kg (double cavity)

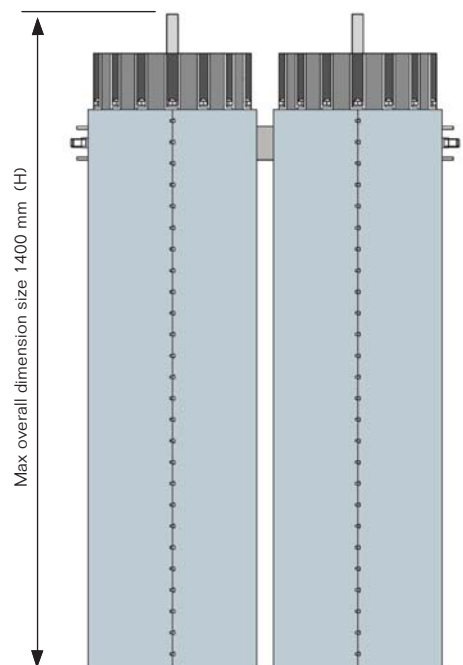
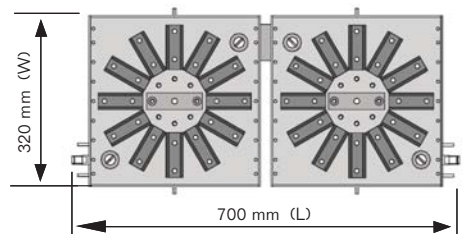

Typical shape of a curves for S11 and S21 parameters

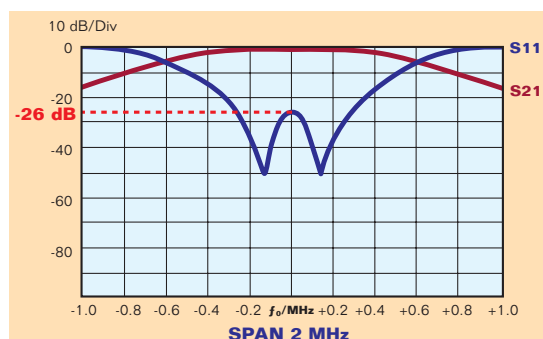

"These specifications are subject to change without notice"

## Model FFC10

- Band-Pass Filter
- FM Band 87.5÷108 MHz
- Band II



**THESE ARE TWO STANDARD RESONANT CAVITY FILTERS, AND IN THE SPECIAL VERSION WITH 3 AND 4.**  
**ALL THE MODELS ARE USED TO MAKE UP MIXERS WITH SEVERAL CHANNELS.**

The band pass filters was designed as an extension of our band pass combiner technology. Using our industry-leading squarecavity filter design, the filter provides a one-time-buy filtering solution for the broadcaster located at multiple-user site. The filter isolates the transmission system to eliminate spurious emissions.

### TYPICAL SPECIFICATIONS

Model	FFC10
Impedance	50 Ohm
Frequency Range	87.5÷108 MHz
VSWR ±150 KHz	1.1:1 Max
Insertion Loss	≤ 0.1 dB
Return Loss ±150 KHz	≤ -26 dB
Rejection	per customer's requirements (Typical ±1MHz it's even to -14 dB)
Connectors	1+5/8" Input-Output (Option 3+1/8")
Max Power	10 KW
Working Temperature	-20°C ÷ +50°C
Colour	Enamel gray ral 7001
Materials	Aluminium, silver brass, copper, PTFE, stainless steel, silver plated (min 12µ thickness)

### Features:

- Modular design
- Distortion – Free Transmission
- Standard configuration of 2 cavities
- Special configuration 3 and 4 cavities
- Low loss, high isolation
- Natural convection

### No Rack Version

Dimensions	1500 (Max size) x 1100 x 500 mm (59-Max Size-X43.3x19.7 inch) (HxLxW)
Net Weight	≅ 60 Kg (double cavity)

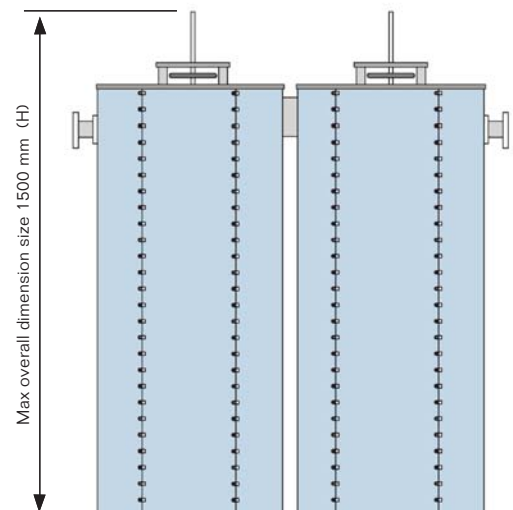
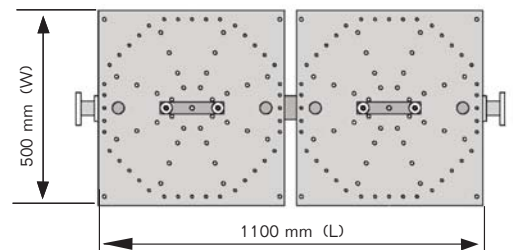

Typical shape of a curves for S11 and S21 parameters

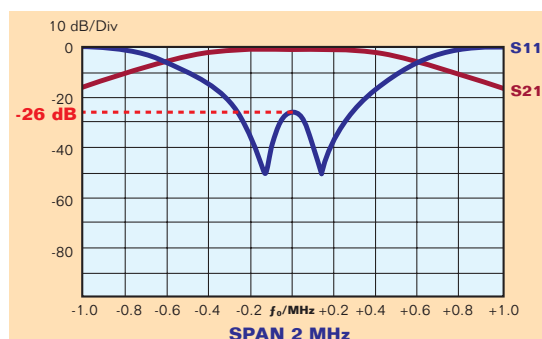

"These specifications are subject to change without notice"

- **Band-Pass Filter**
- **FM Band 87.5÷108 MHz**
- **Band II**

**THESE ARE TWO STANDARD RESONANT CAVITY FILTERS, AND IN THE SPECIAL VERSION WITH 3 AND 4.**  
**ALL THE MODELS ARE USED TO MAKE UP MIXERS WITH SEVERAL CHANNELS.**

The band pass filters was designed as an extension of our band pass combiner technology. Using our industry-leading squarecavity filter design, the filter provides a one-time-buy filtering solution for the broadcaster located at multiple-user site. The filter isolates the transmission system to eliminate spurious emissions.



### TYPICAL SPECIFICATIONS

Model	FFC20
Impedance	50 Ohm
Frequency Range	87.5÷108 MHz
VSWR ±150 KHz	1.1:1 Max
Insertion Loss	≤ 0.1 dB
Return Loss ±150 KHz	≤ -26 dB
Rejection	per customer's requirements (Typical ±1MHz it's even to -14 dB)
Connectors	3+1/8" Input-Output
Max Power	20 KW
Working Temperature	-20°C ÷ +50°C
Colour	Enamel gray ral 7001
Materials	Aluminium, silver brass, copper, PTFE, stainless steel, silver plated (min 12µ thickness)

### Features:

- Modular design
- Distortion – Free Transmission
- Standard configuration of 2 cavities
- Special configuration 3 and 4 cavities
- Low loss, high isolation
- Natural convection

### No Rack Version

Dimensions	1500 (Max size) x 1150 x 500 mm (59"Max Size x 45.3x 19.7 inch) (HxLxW)
Net Weight	≈ 58 Kg (double cavity)

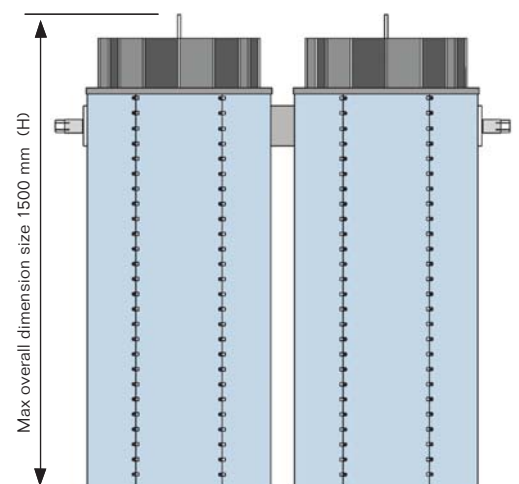
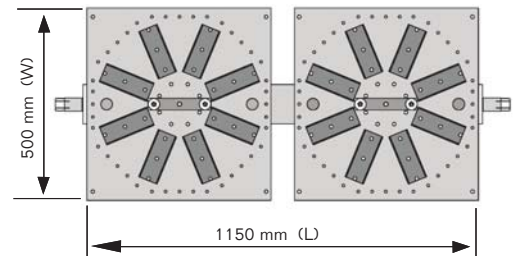

Typical shape of a curves for S11 and S21 parameters

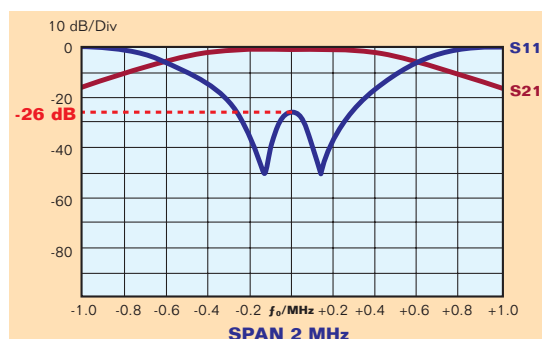

"These specifications are subject to change without notice"

## Model FFC30

- Band-Pass Filter
- FM Band 87.5÷108 MHz
- Band II

THESE ARE TWO STANDARD RESONANT CAVITY FILTERS, AND IN THE SPECIAL VERSION WITH 3 AND 4.

ALL THE MODELS ARE USED TO MAKE UP MIXERS WITH SEVERAL CHANNELS.

The band pass filters was designed as an extension of our band pass combiner technology. Using our industry-leading squarecavity filter design, the filter provides a one-time-buy filtering solution for the broadcaster located at multiple-user site.

The filter isolates the transmission system to eliminate spurious emissions.



### TYPICAL SPECIFICATIONS

Model	FFC10
Impedance	50 Ohm
Frequency Range	87.5÷108 MHz
VSWR ±150 KHz	1.1:1 Max
Insertion Loss	≤ 0.1 dB
Return Loss ±150 KHz	≤ -26 dB
Rejection	per customer's requirements (Typical ±1MHz it's even to -14 dB)
Connectors	3+1/8" Input-Output
Max Power	30 KW
Working Temperature	-20°C ÷ +50°C
Colour	Enamel gray ral 7001
Materials	Aluminium, silver brass, copper, PTFE, stainless steel, silver plated (min 12µ thickness)

### Features:

- Modular design
- Distortion – Free Transmission
- Standard configuration of 2 cavities
- Special configuration 3 and 4 cavities
- Low loss, high isolation
- Natural convection

### No Rack Version

Dimensions	1500 (Max size) x 1150 x 500 mm (59-Max Size-x45.3x19.7 inch) (HxLxW)
Net Weight	≈ 58 Kg (double cavity)

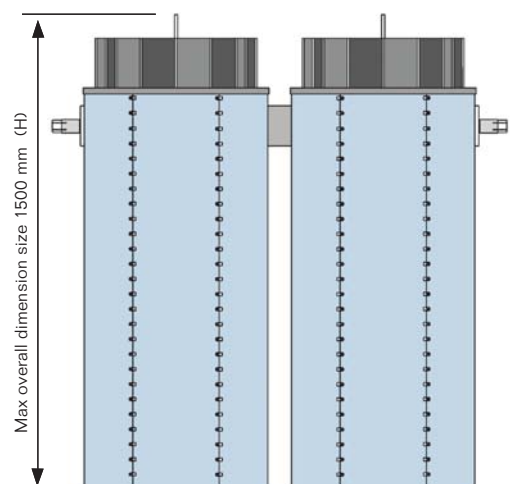
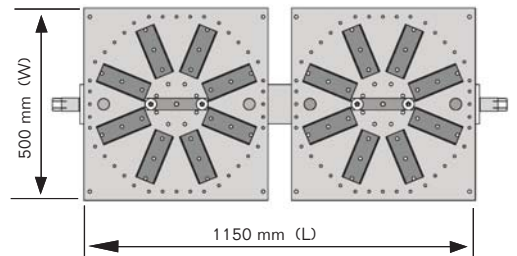

Typical shape of a curves for S11 and S21 parameters

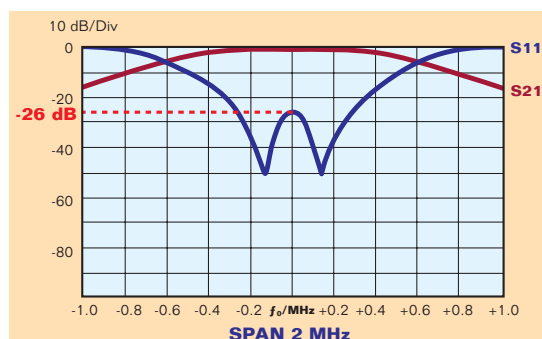

"These specifications are subject to change without notice"